

General Building Supervisory Approval

Approval Authority for Building Products and
Building Types

Constructional Audit Office

A public agency funded by the Federation and
the Länder

Member of EOTA, UEAtc and WFTAO

Date:

Reference:

23.02.2017

I 3-1.14.7-102/14

Approval number:

Z-14.7-557

Validity period:

from: **5th January 2017**

to: **5th January 2022**

Applicant:

Jakob AG
3555 Trubschachen
Switzerland

Subject of approval:

Rope net constructions Jakob Rope Systems Webnet

The aforementioned subject of approval is hereby granted general building supervisory approval.

This General Building Supervisory Approval comprises seven pages and 14 annexes.

This General Building Supervisory Approval replaces the general building supervisory approval No. Z-14.7-557 dated the 5th January 2012

"Vom Deutschen Institut für Bautechnik nicht geprüfte Übersetzung der deutschen Originalfassung"

"Translation of the original German language version not verified by the German Institute for Structural Engineering"

DIBt

I General Provisions

- 1 The General Building Supervisory Approval verifies the usability and/or applicability of the subject of approval in terms of state building regulations (Landesbauveordnungen).
- 2 So far as the general building supervisory approval lays down requirements for the special expertise and experience of the persons entrusted with the manufacture of building products and building types pursuant to § 17 Para. 5 of the model building code of the corresponding federal state regulations, it should be noted that said expertise and experience can also be corroborated by equivalent supporting documents from other European Union member states. This shall also apply, when applicable, to equivalent supporting documents submitted within the framework of the European Economic Area (EEA) Agreement or other bilateral agreements.
- 3 The General Building Supervisory Approval shall not replace the permits, consents and certification that are legally required for the execution of building projects.
- 4 The General Building Supervisory Approval is issued without prejudice to the rights of third parties, in particular private property rights.
- 5 Manufacturer and distributor of the subject of approval must, irrespective of further regulations in the "special provisions", provide the user or operator of the subject of approval with copies of the General Building Supervisory Approval and advise them that the General Building Supervisory Approval must be present at the place of use. Upon request, the authorities involved are to be provided with copies of the General Building Supervisory Approval.
- 6 The General Building Supervisory Approval may only be reproduced in its entirety. Publication of excerpts shall require the consent of the German Institute for Structural Engineering. Texts and drawings used in promotional materials may not contradict the General Building Supervisory Approval. Translations of the General Building Supervisory Approval must contain the note "Vom Deutschen Institut für Bautechnik nicht geprüfte Übersetzung der deutschen Originalfassung"
- 7 The General Building Supervisory Approval is issued subject to possible later revocation. The provisions of the General Building Supervisory Approval can be subsequently supplemented and amended, if new technical findings require this.

II SPECIAL PROVISIONS

1 Subject of approval and scope of application

The subject of approval comprises prefabricated rope net constructions designated "Jakob Rope Systems Webnet", consisting of stainless steel ropes (net ropes, threading ropes) and associated sleeves (net sleeves "Inox" and "Micro", empty sleeves and webnet-eyelets) for rope joining and redirection, as well as boundary ropes or circular tube frames serving as rope net surround. Sleeveless (intertwined) nets are possible. The boundary ropes are anchored using corresponding components (end anchorages). The frames are fastened to the adjoining construction using special frame holders and frame clamps. For nets with rope diameters of 1.5 mm and 2.0 mm and mesh sizes of 25 mm to 120 mm, an internally located boundary connection (Invis) without threading rope is possible (see Annexes 1 to 3).

The boundary ropes must not be redirected.

The opening angle of the rope net mesh is between 30° and 90°. Mesh size is variable and, depending on rope diameter, sleeve and application, lies between 20 mm and 120 mm. The permitted mesh sizes and possible mesh geometries for the standard mesh angle 60° are specified in Annexes 5 and 6.

The executed structure comprises either vertical rope nets (e.g. railings) or horizontal rope nets. Rope nets can be employed to prevent falls (e.g. for helicopter landing pads, viewing towers or bridges). Further application areas are e.g. rope net constructions for animal enclosures or facades.

This General Building Supervisory Approval governs the manufacture, dimensioning and use of prefabricated rope nets. Also applicable are the regulations specified in DIN EN 1993-1-11¹, in the associated application standards and in General Building Supervisory Approval No. Z-30.3-6, unless otherwise specified in this General Building Supervisory Approval.

Use of so-called closed nets in which the boundary connection is achieved using net rope loops is not permitted.

2 Provisions relating to Building Products

2.1 Properties and composition

2.1.1 Ropes (net ropes, threading ropes)

The data in DIN EN 10264-4² and in the DIN EN 12385³ standards series are applicable to the ropes. Attention must also be paid to the data in Annex 12, Table 12.1

2.1.2 Boundary ropes

The data in DIN EN 10264-4² and in the DIN EN 12385³ standards series are applicable to the boundary ropes. Attention is also to be paid to the data in Annex 12, Table 12.1.

¹ DIN EN 1993-1-11:2010-12 Eurocode 3: Dimensioning and construction of steel structures - Part 1-11: Dimensioning and construction of steel load-bearing structures with tension components in conjunction with DIN EN 1993-1-11/NA:2010-12

² DIN EN 10264-4:2002-11 Steel wire and wire products - steel wire for ropes - Part 4: Stainless steel wire

³ DIN EN 12385 Steel wire ropes - safety

2.1.3 Net sleeves, empty sleeves, Webnet-eyelets

Net sleeves, empty sleeves and Webnet-eyelets consist of stainless steel with material number 1.4404 according to DIN EN 10088-3⁴. The details in Annex 4 are applicable. Tensile strength must be at least 500 N/mm². Detailed dimension information is lodged with the German Institute for Structural Engineering.

2.1.4 Threading rope end anchorages

The ends of the threading ropes are joined using two pressed empty sleeves according to section 2.1.3.

2.1.5 Boundary rope end anchorages (clevis, turnbuckles with clevis)

Boundary rope end anchorages consist of stainless steel of material class 1.4401 according to DIN EN 10088-3⁴ with a minimum tensile strength of 500 N/mm². The clevis and turnbuckles with clevis must have metric ISO-thread M10 to M36 according to the DIN 13 standards series. The data in the corresponding DIN 13 standards series are applicable to thread tolerances. The details in Annexes 9 to 11 are otherwise applicable.

2.1.6 Frames

Frames are manufactured from round hollow or square hollow steel sections of type S355 according to the DIN EN 10210⁵/DIN EN 10219⁶ standards series, or from stainless steel (suitable for hollow sections) according to General Building Supervisory Approval Z-30.3-6 with at least strength class S235. The data in Annexes 13 and 14 are applicable regarding dimensions. Alternatively, round tubing sections with a lower bending strength may be used.

2.1.7 Frame clamps, frame holders

Frame clamps and frame holders consist of stainless steel of material class 1.4401 according to DIN EN 10088-3⁴. Tensile strength must be at least 500 N/mm². The information in Annexes 7 and 8 and that lodged with the German Institute of Structural Engineering is applicable regarding dimensions.

2.1.8 Rope net manufacture

The precise details regarding the manufacture of rope nets is lodged with the German Institute of Structural Engineering.

2.1.9 Corrosion resistance

The rope nets are to be classified into corrosion-resistance class (CRC) II in accordance with DIN EN 1993-1-4⁷ in conjunction with DIN EN 1993-1-4/NA:2017-01⁸.

2.2 Labeling

Rope net packaging must be labeled by the manufacturer with the conformity marking ('Ü-Zeichen') in accordance with the federal states conformity marking ordinance. Labeling may only take place following compliance with the conditions described in Section 2.3.

⁴ DIN EN 10088-3:2005-09 Stainless steels - Part 3: Technical delivery conditions for semi-finished products, rods, wire rods, drawn wire, sections and bright steel products made of corrosion-resistant steels for general usage.

⁵ DIN EN 10210:2006-07 Hot finished structural hollow sections of non-alloy and fine grain steels.

⁶ DIN EN 10219:2006-07 Cold finished welded structural hollow sections of non-alloy and fine grain steels.

⁷ DIN EN 1993-1-4:2015-10 Eurocode 3: Dimensioning and construction of steel structures - Part 1-4: General dimensioning rules - supplementary rules for the implementation of stainless steels

⁸ DIN EN 1993-1-4/ NA:2017-01 National annex- Nationally stipulated parameter - Eurocode 3: Dimensioning and construction of steel structures - Part 1-4: General dimensioning rules - supplementary rules for the implementation of stainless steels

The production plant, production year, the building product designation and material for the individual components must also arise from the label.

2.3 Verification of conformity

2.3.1 General

Confirmation of rope net compliance with the provisions of this General Building Supervisory Approval must, for each manufacturing plant, take place with a certificate of conformity ('Ü-Zeichen') based on an in-house production control and regular third party monitoring, including an initial inspection of the rope nets in accordance with the provisions set out below.

The rope net manufacturer must engage a recognized certification authority for the issuance of the certificate of conformity, as well as a recognized monitoring authority for external monitoring and associated product testing activities.

The manufacturer must declare the issuance of a certificate of conformity by labeling the building products with the conformity mark and indicating the application.

The German Institute for Structural Engineering shall, for information purposes, be given a copy of the certificate of conformity by the issuing certification authority. The German Institute for Structural Engineering shall, in addition, be furnished with a copy of the initial test report for information purposes.

2.3.2 In-house production control

An in-house production control shall be established and implemented in each manufacturing plant. An in-house production control is understood to mean continuous monitoring of production performed by the manufacturer, by means of which it ensures that the building products it manufactures comply with the provisions of this General Building Supervisory Approval.

The in-house production control shall comprise at least the below stated measures.

– Ropes, boundary ropes

The dimensions specified in Section 2.1 must be verified for every delivery. The material characteristics specified in Section 2.1 shall be verified by an acceptance test certificate 3.1 according to DIN EN 10204⁹. The technical delivery conditions according to DIN EN 10264-4² and the standards of the DIN EN 12385³ series must be observed.

– Rope sleeves, empty sleeves, Webnet-eyelets, end anchorages

The dimensions and tolerances specified in Section 2.1 must be verified for every production batch. The material characteristics specified in Section 2.1 must be verified by an acceptance test certificate 3.1 according to DIN EN 10204⁹.

– Verification of loading bearing values and pressings

Load bearing values for individual meshes, boundary connections and the boundary ropes and pressings (rope with sleeve, rope with Webnet-eyelet, rope with clevis or turnbuckle and end anchorage of the threading rope) shall be regularly verified by tensile testing of individual meshes, boundary connections and boundary ropes with associated sleeves and end anchorages. The type, scope and frequency of these tests shall be agreed with the monitoring body engaged to perform external monitoring and with the German Institute for Structural Engineering on the occasion of the initial inspection (see Section 2.3.3).

In-house production control results must be recorded and evaluated. The records must contain at least the below stated information.

⁹ DIN EN 10204:2005-01 Metallic Products - Types of Inspection Certificates

- Name of the building product or of the starting material and the components.
- Type of inspection or test
- Date of manufacture and testing of the building products and the starting material or the components
- Result of inspections and tests and comparison with specifications.
- Signature of in-house person responsible for production control.

The records must be preserved for at least five years and submitted to the monitoring body engaged to perform external monitoring. They must, upon request, be submitted to the German Institute for Structural Engineering and the highest responsible building supervisory authority.

In the event of unsatisfactory testing results, the manufacturer shall, without delay, adopt the measures that are necessary to correct the defect. Building products that do not meet the necessary requirements, shall be handled in a manner that prevents their confusion with compliant products. Following defect correction, the relevant test shall - insofar as this is technically feasible and necessary to verify corrective action - be immediately repeated.

2.3.3 External monitoring

The in-house production control in every manufacturing plant, shall be regularly reviewed by an external monitor, though at least twice per annum.

External monitoring shall include carrying out an initial testing of the building product and random testing of the characteristics of the building product as specified in Section 2.1. The minimum screw insertion depth measurement specified in Annex 9 must be verified. The initial testing data are deposited with the German Institute for Structural Engineering.

Sampling and tests are, in each case, the responsibility of the recognized authority. The measured values obtained by external monitoring must verify the fulfillment of the required specifications.

Certification and external monitoring results shall be preserved for at least five years. The certifying and monitoring authorities shall, upon request, submit said results to the German Institute for Structural Engineering and to the highest responsible building supervisory authority.

3 Design and dimensioning provisions

3.1 Verification of load-bearing safety

3.1.1 General

The verification concept stipulated in DIN EN 1993-1-11¹⁰ shall be applicable to the verification of rope net load-bearing safety.

The diameter of the threading rope must exceed that of the net rope (e.g. a threading rope with a 2.0 mm diameter for a net rope with a 1.5 mm diameter).

The applicable technical building regulations must be observed for the verification of circular tube frame load-bearing safety and for the verification of load introduction and load transmission in the underlying construction.

In the case of framing with boundary ropes, appropriate constructive measures must be taken to ensure that the clevis can also rotate freely in the plane of the rope net in the event of marked deformation of the boundary rope, so as to avoid the occurrence of proscribed bending stress in the clevis.

¹⁰ DIN EN 1993-1-11:2010-12 Eurocode 3: Dimensioning and construction of steel structures Part 1-11: Dimensioning and construction of supporting structures with steel tension components;

The verification concept specified in Annex D.2 of DIN 18008-4¹¹ shall be applicable to the verification of mounting structure shock resistance. Each mounting must have a typical bearing capacity of at least 2.8 kN.

3.1.2 Rope and boundary rope elasticity

The data in DIN EN 1993-1-1¹¹ apply.

3.2 Verification of fall protection

The rope nets may only be used without an additional verification of fall-protection subject to compliance with the conditions specified in Annexes 13 and 14.

4 Implementation provisions

The manufacturer shall prepare implementation instructions for the installation of the prefabricated rope nets and deliver these to the building contractor. The installation may only be carried out by trained personnel.

The faultless condition of all individual rope net components must be verified prior to installation. Damaged parts must not be used. Boundary ropes must not be redirected.

Manual, on-site pressing of net and empty sleeves, or of Webnet eyelets according to Section 2.1.3 is only permitted with "type EK 22, EK 35/4 and EK 50ML battery-powered presses" from the company Jakob AG.

For end-anchored boundary ropes, the minimum screw insertion depth of the rope or of the clevis in the turnbuckle shall comply with the dimension "c" according to Annex 9.

Verification of compliance with the minimum screw insertion depth for all threaded connections must be recorded in an endorsement by the person responsible for installation.

In the case of fall-protected systems, the relevant components shall, following their installation, undergo regular testing with respect to functionality and the possible presence of corrosion damage. Evidence of these inspections must be logged.

Compliance of the adjacent construction and of the installation of the prefabricated rope net with the provisions of this General Building Supervisory Approval shall be certified by the contracting building company.

Uwe Bender,
Head of Departement

Certified



¹¹ DIN 18008-4:2013-07

Glass in the building sector - Dimensioning and construction regulations Part 4: Supplementary requirements for fall-prevention glazing

Example 1: Rope net with boundary rope

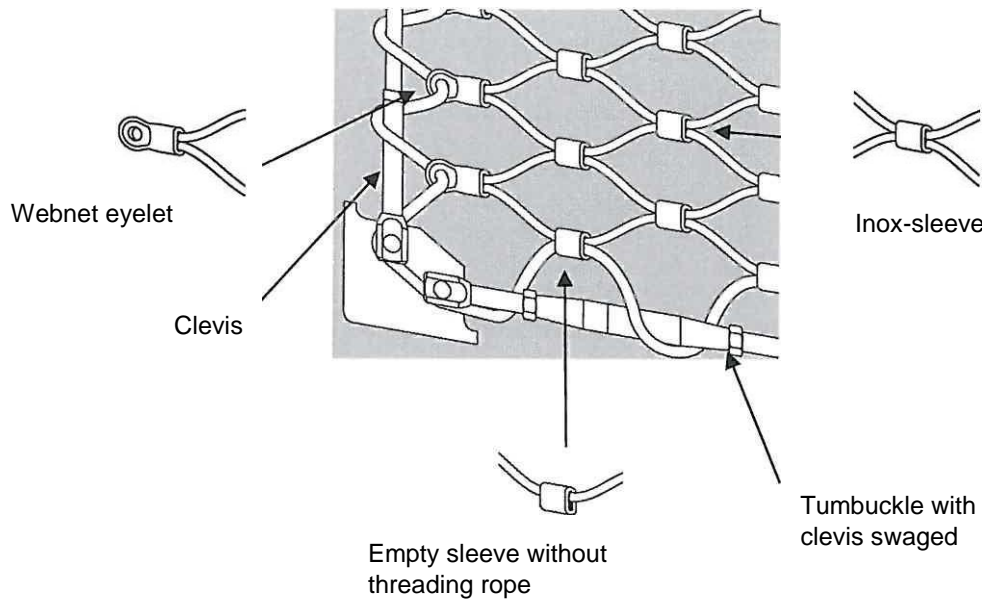

Example 2: Rope net with frame

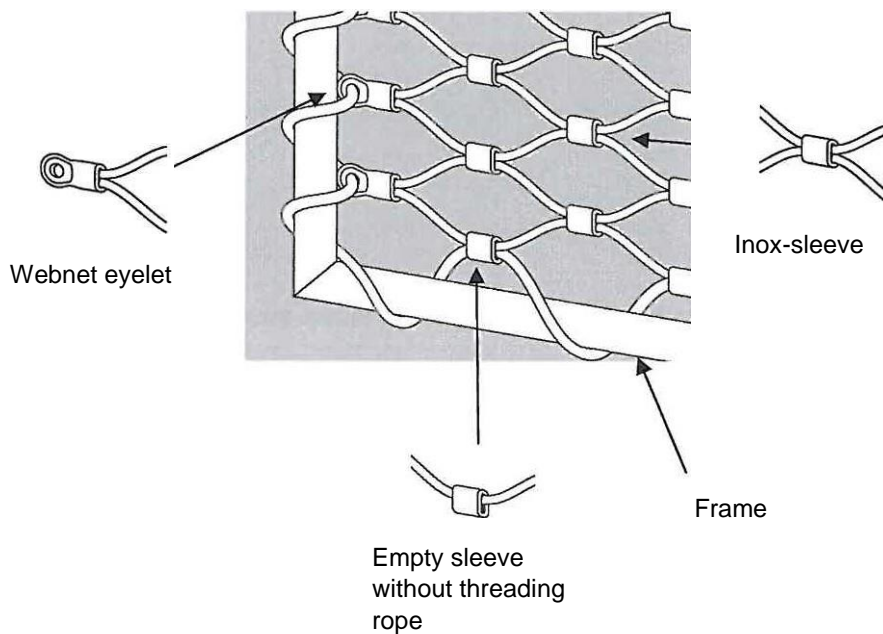

Rope net constructions Jakob Rope Systems Webnet

Examples for rope nets

Annex 1

Example 3: Rope net with internally located boundary connection 'Invis'

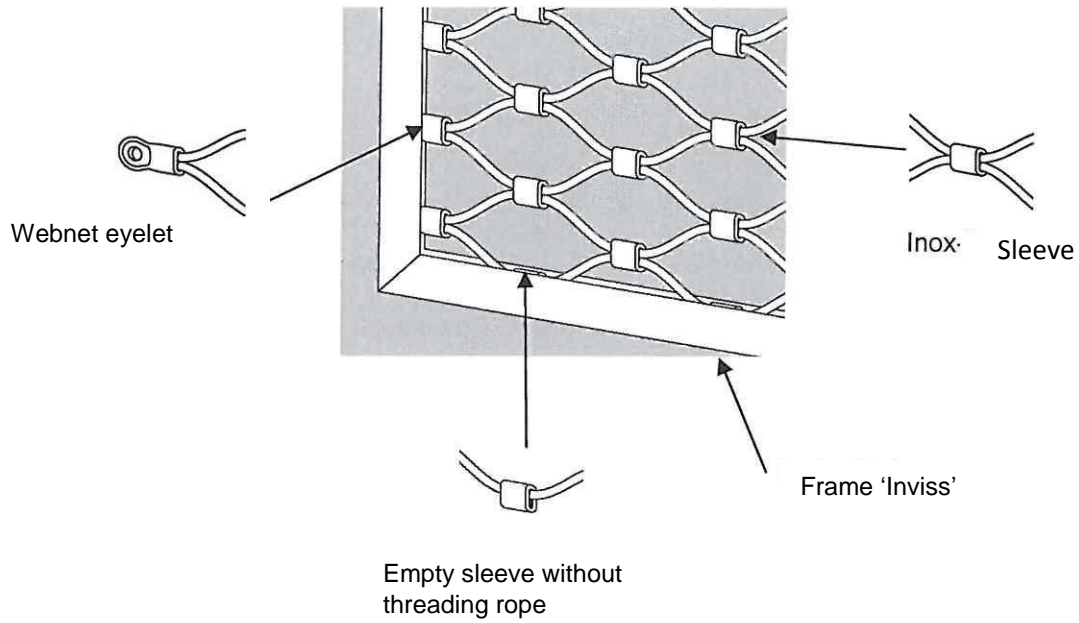

Example 4: Sleeveless rope net with frame

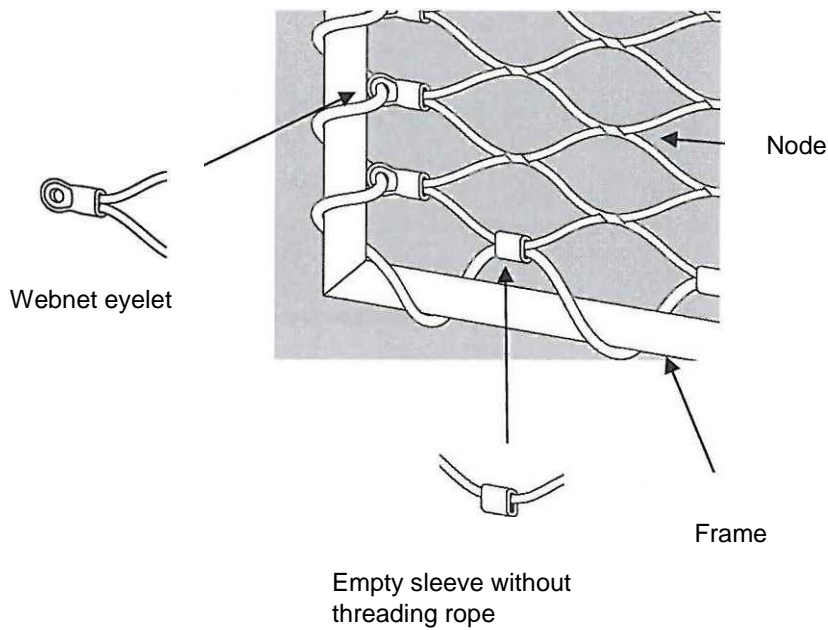

Rope net constructions Jakob Rope Systems Webnet

Examples for rope nets

Annex 2

Example 5: Rope net with frame and frame holder

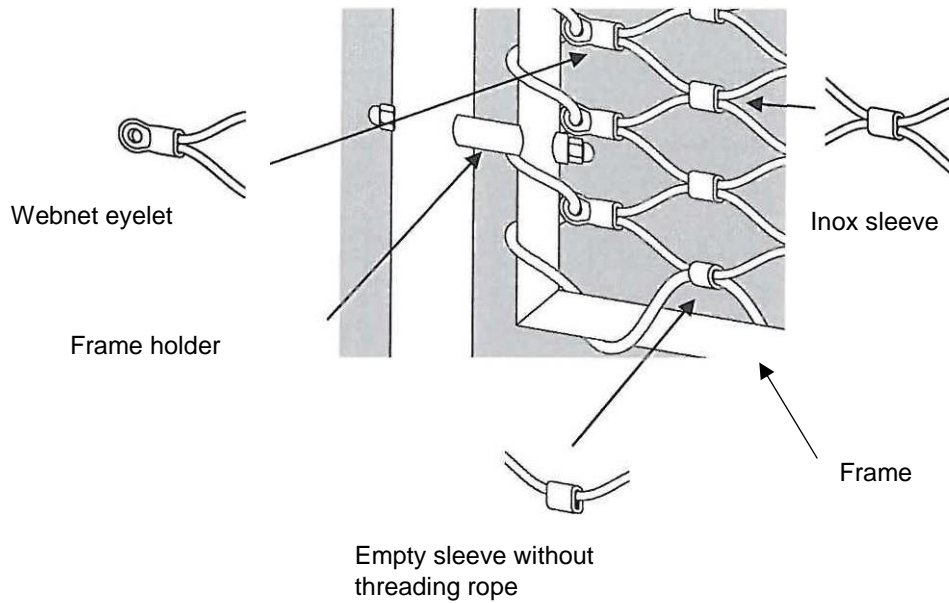

Example 6: Rope net with frame and frame clamps

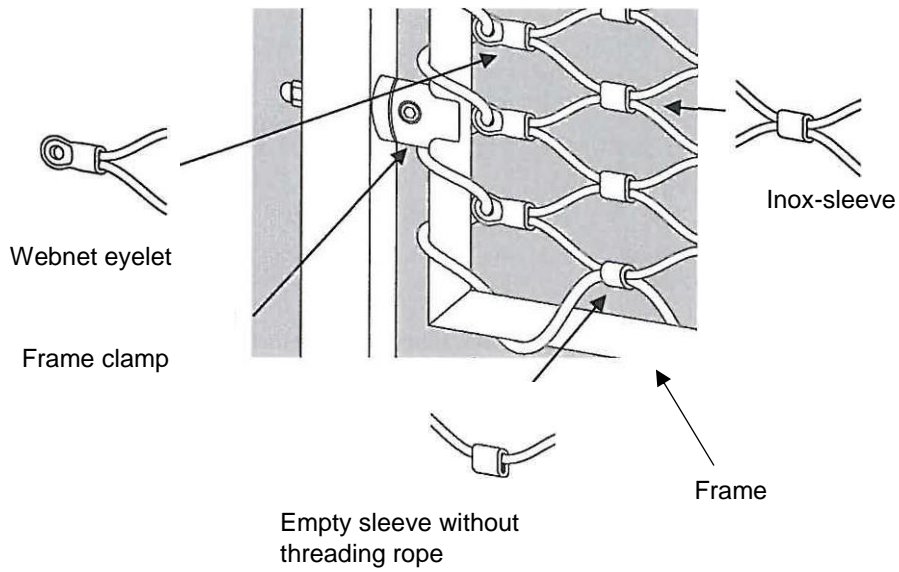

Rope net constructions Jakob Rope Systems Webnet

Examples for rope nets

Annex 3

Table 4.1: Net sleeves and empty sleeves

Name	Art. No :	Material	Rope Ø [mm]	b [mm]	Ø d* [mm]	Ø d2* [mm]	Rope sleeve pressed	
							A [mm]	t [mm]
Inox-sleeve	30584-0150	1.4404	1,5	7,3	5,7	3,7	7,5	2,8
	30584-0200		2,0	10,0	7,0	4,7	9,0	3,5
	30584-0300		3,0	11	8,3	6,0	10,8	4,5
Micro sleeve	30584-0150-20		1,5	5,5	-	-	6,0	2,7

* unpressed

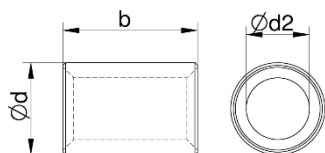

Table 4.2: Empty sleeve Inox pressed

Net rope Ø [mm]	Threading rope Ø [mm]	A [mm]	b [mm]	t [mm]
1,0	1,5	5,0	4,0	2,5
1,5	2,0	7,0	7,3	3,5
2,0	2,5	10,0	10,0	4,8
3,0	4,0	11,0	11,0	6,5
4,0	5,0	16,0	13,0	7,5
5,0	6,0	19,0	20,0	8,5

Sleeve pressed

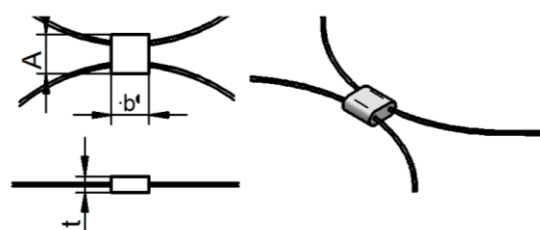
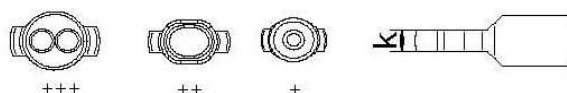
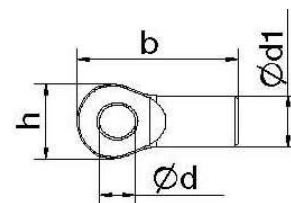

Table 4.3: Webnet-eyelets

Art. No. 30880-	Material	Rope Ø [mm]	b [mm]	Ød [mm]	h [mm]	k [mm]	Ød1* [mm]
0100-01 ++ 0100-02 +	1.4404	1,0	13,0	2,0	5,0	2,5	4,0
0150-01 ++ 0150-02 +		1,5	16,0	3,0	8,3	3,0	6,0
0200-01 ++ 0200-02 +		2,0	20,0	4,5	10,0	3,0	7,0
0300-01 +++ 0300-02 +		3,0	30,0	5,0	14,0	5,0	10,0
0400-01 +++ 0400-02 +		4,0	48,0	7,0	18,0	6,0	14,0
0500-01 +++ 0500-02 +		5,0	65,0	9,0	22,0	6,0	16,0

*unpressed



Rope net constructions Jakob Rope Systems Webnet

Material and geometry
Net sleeves, empty sleeves and Webnet-eyelets

Annex 4

Table 5.1: Net assembly and dimensions for nets with Inox sleeves

Sleeve	∅ Stranded wires and structure	Mesh width [mm]
Inox	2,0 mm 6x7+WC 3,0 mm 6x19+WC	40 to 120 40 to 120

Table 5.2: Mesh geometry for standard mesh angle 60°, inox-sleeves

Art No.	Rope ∅ [mm]	Mesh width W* [mm]	Mesh height H* [mm]
20256-0200-040	2,0	40	75,1
20256-0200-050		50	90,5
20256-0200-060		60	106
20256-0200-070		70	124
20256-0200-080		80	141
20256-0200-100		100	175
20256-0200-120		120	209
20256-0300-040	3,0	40	74,8
20256-0300-050		50	90,5
20256-0300-060		60	106
20256-0300-070		70	124
20256-0300-080		80	141
20256-0300-100		100	175
20256-0300-120		120	209

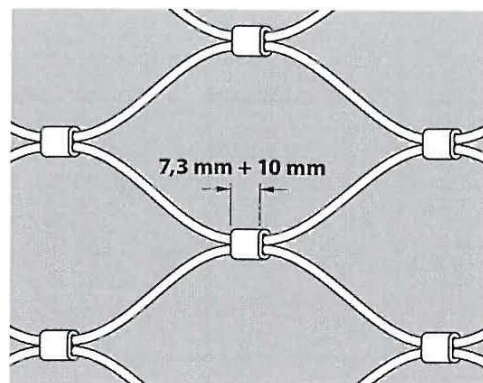

* The specified values are applicable to the standard mesh angle 60°. Mesh height changes with other mesh angles.

Table 5.3: Net assembly and dimensions for nets with micro-sleeves

Sleeve type	∅ Stranded wires and structure	Mesh width [mm]
Micro	1,5 mm 6x7+WC	25 to 120

Table 5.4: Geometry for standard mesh angle 60°, micro-sleeves

Art. No.	Câble ∅ [mm]	Largeur des mailles W* [mm]	Hauteur des mailles H* [mm]
20261-0150-025	1,5	25	45,5
20261-0150-030		30	60,7
20261-0150-035		35	68
20261-0150-040		40	75,4
20261-0150-050		50	91,4
20261-0150-060		60	107,8
20261-0150-070		70	124,8
20261-0150-080		80	141,5
20261-0150-100		100	175,3
20261-0150-120		120	210,4

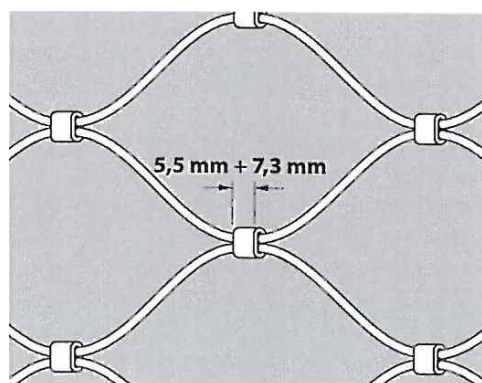

* The specified values are applicable to the standard mesh angle 60°. Mesh height changes with other mesh angles.

Rope net constructions Jakob Rope Systems Webnet

Mesh geometry for standard mesh angle 60°

Annex 5

Table 6.1: Net assembly and dimensions for sleeveless nets

Sleeve type	∅ Stranded wire rope and structure	Mesh width [mm]
Sleeveless	1,5 mm 6x7+WC	30 to 120
	2,0 mm 6x7+WC	40 to 120
	3,0 mm 6x19+WC	40 to 120
	4,0 mm 6x19+WC	40 to 120
	5,0 mm 6x19+WC	100 to 120

Table 6.2: Mesh geometry for standard mesh angle 60°, sleeveless

Art. No.	Rope ∅ [mm]	Mesh width W* [mm]	Mesh height H* [mm]
20260-0150-030	1,5	30	60,2
20260-0150-040		40	74,8
20260-0150-050		50	89,7
20260-0150-060		60	105,7
20260-0150-070		70	124,6
20260-0150-080		80	139,6
20260-0150-100		100	174,6
20260-0150-120		120	208,5
20260-0200-040	2,0	40	74,8
20260-0200-050		50	88,3
20260-0200-060		60	105,7
20260-0200-070		70	122,5
20260-0200-080		80	139,5
20260-0200-100		100	173,3
20260-0200-120	120	207,3	
20260-0300-040	3,0	40	72,4
20260-0300-050		50	88,3
20260-0300-060		60	105,7
20260-0300-070		70	122,5
20260-0300-080		80	139,5
20260-0300-100		100	173,3
20260-0300-120	120	207,3	
20260-0400-040	4,0	40	72,4
20260-0400-050		50	88,3
20260-0400-060		60	105,7
20260-0400-070		70	122,5
20260-0400-080		80	139,5
20260-0400-100		100	173,3
20260-0400-120	120	207,3	
20260-0500-100	5,0	100	173,3
20260-0500-120		120	207,3

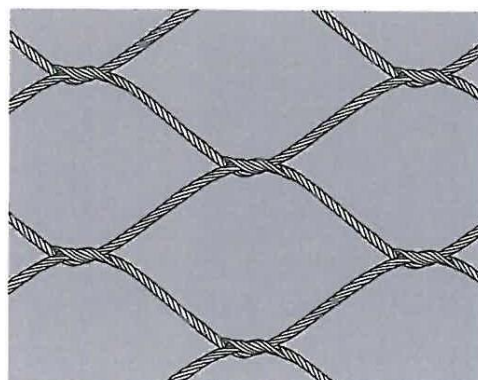

* The specified values are applicable to the standard mesh angle 60°. Mesh height changes with other mesh angles.

Rope net constructions Jakob Rope Systems Webnet

Mesh geometry for standard mesh angle 60°

Annex 6

Frame clamps

Frame clamp one-sided

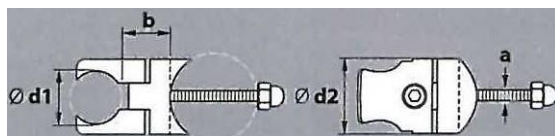

Frame clamp double-sided

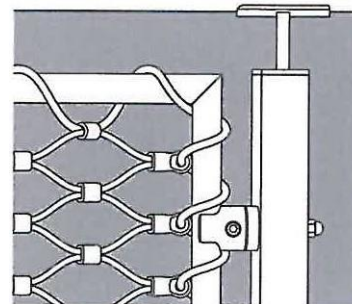
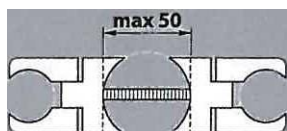
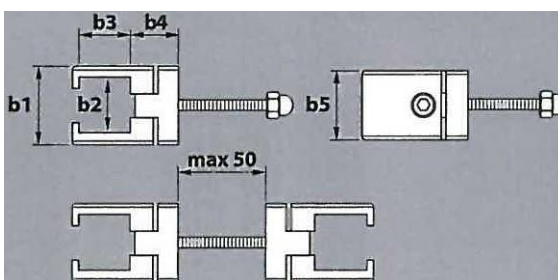

Table 7.1: Material and dimensions frame clamps round, distance 25 mm

Art. No..	Material	a	b [mm]	Ø d1 [mm]	Ø d2 [mm]
30917-0017-xx	1.4401	M6	25	17,2	33
30917-0026-xx		M6	25	26,9	42

Frame clamp one-sided



Frame clamp double-sided

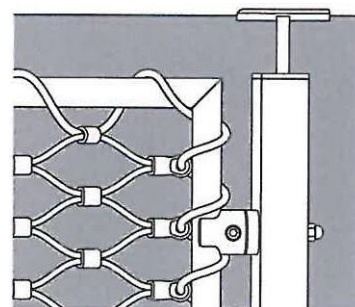

Table 7.2: Material and dimensions frame clamp square, distance 25 mm

Art. No.	Material	a	b1 [mm]	b2 [mm]	b3 [mm]	b4 [mm]	b5 [mm]
30917-0020-01/02	1.4401	M6	30	20	20	25	30
30917-0030-01/02		M6	40	30	30	25	30

Rope net constructions Jakob Rope Systems Webnet

Frame clamps

Annex 7

Frame holder

Frame holder one-sided

Frame holder double-sided

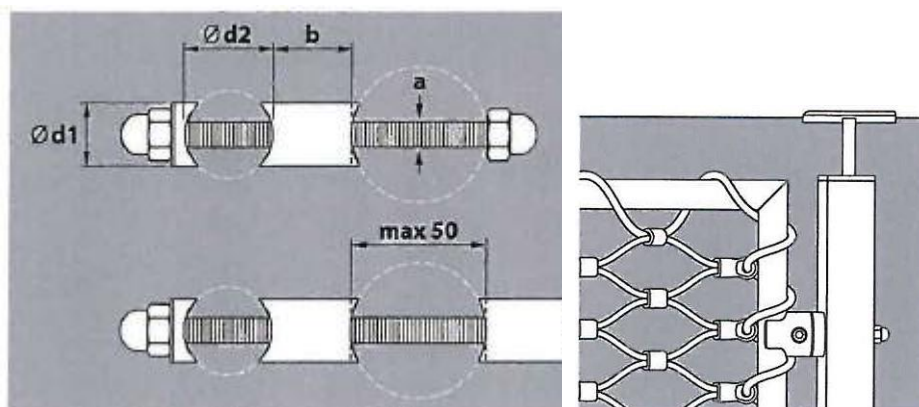

Table 8.1 : Material and dimensions of frame holders, distance 25 mm

Art. No.	Material	a	b [mm]	Ø d1 [mm]	Ø d2 [mm]
30917-0017-xx	1.4401	M6	25	13	17,2
30917-0026-xx		M8	25	18	26,9

Rope net constructions Jakob Rope Systems Webnet

Frame holder

Annex 8

Turnbuckle with clevis swaged

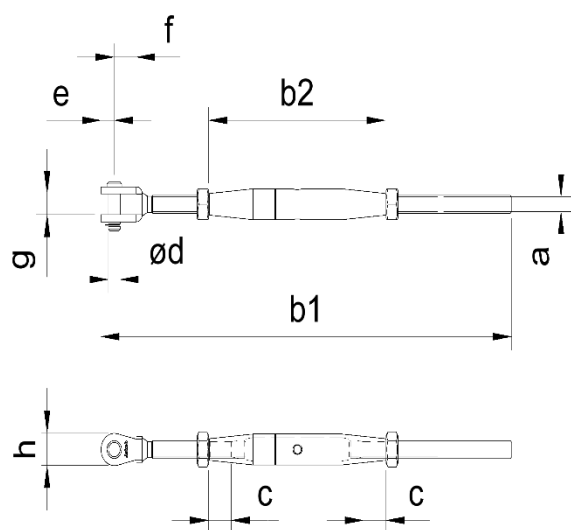

c: Screw insertion depth of rope or turnbuckled
with clevis swaged
 $c \geq 1,5 \times \text{rope diameter}$

Table 9.1: Material and dimensions of turnbuckle with clevis swaged

Art. No.	Rope Ø [mm]	Material	a	b1 [mm]	b2 [mm]	Ø d [mm]	E [mm]	f [mm]	g [mm]	h [mm]	Tension distance [mm]	(+)	(-)
30870-0600	6,0	1.4401	M10	282	120	8	9	15	11	18	30	50	
30870-0800	8,0		M12	348	150	12	14	25	14	26	46	60	
32870-0800-01				411	16	12	15	24	14	31	41	64	
30870-1000	10,0		M16	467	190	14	18	32	22	34	48	78	
32870-1000-01				482	180	16	20	30	18	40	39	70	
30870-1200	12,0		M20	554	220	19	23	43	24	43	50	98	
32870-1200-01				558	200	20	24	38	22	48	36	76	
32870-1400-01	14,0		M24	678	240	25	29	47	26	58	44	92	
30870-1600	16,0			573	212	25	35	40	25	63	44	82	
32870-1600-01				700	240	25	29	47	26	58	44	92	
32870-1900-01	19,0		M30	850	300	32	38	60	32	75	56	118	
32870-2200-01	22,0			878	300	32	38	60	32	75	56	118	
32870-2600-01	26,0		M36	971	320	36	45	65	38	90	48	120	

Article group 30870 must only be used in combination with round strand ropes.

Article group 32870 must only be used in combination with spiral ropes.

Rope net constructions Jakob Rope Systems Webnet

Turnbuckle with clevis swaged

Annex 9

Clevis swaged

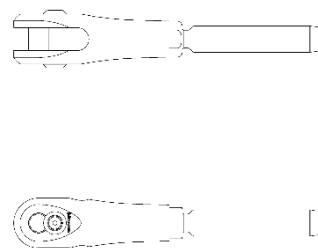
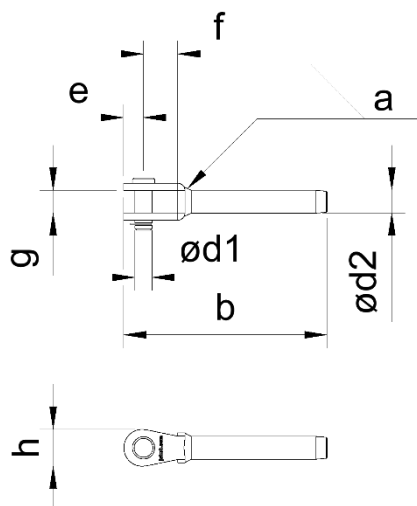

Figure: Clevis, Article group 32881

Table 10.1: Material and dimensions of clevis swaged

Art. No.	Rope Ø [mm]	Material	b [mm]	Ød1 [mm]	Ød2 [mm]	e [mm]	f [mm]	g [mm]	h [mm]	Weld a [mm]
30881-0600	6,0	1.4401	113	9,5	12,7	11	19	12,5	20,5	4
30881-0800	8,0		144	12	16	14	26	15	26	5
32881-0800-01			174	12	16,1	15	24	14	31	-
30881-1000	10,0		165	14	18	18	32	22	34	5
30881-1000-01			218	16	17,9	20	30	18	40	-
30881-1200	12,0		205	16	20	18	32	22	34	6
32881-1200-01			268	20	21,4	24	38	22	48	-
32881-1400-01	14,0		321	25	25	29	47	26	58	-
30881-1600	16,0		285	25	28,2	35	40	25,4	63	6
32881-1600-01			338	25	28,2	29	47	26	58	-
32881-1900-01	19,0		408	32	34,5	38	60	32	75	-
32881-2200-01	22,0		437	32	40,5	38	60	32	75	-
32881-2600-01	26,0		501	36	46	45	65	38	90	-

Article group 30881 must only be used in combination with round strand ropes.

Article group 32881 must only be used in combination with spiral ropes.

Rope net constructions Jakob Rope Systems Webnet

Clevis swaged

Annex 10

External threads swaged

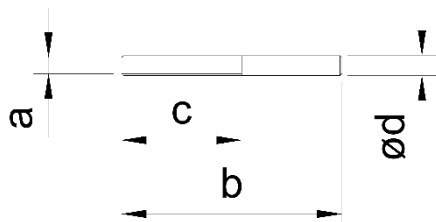

Table 11.1: Material and dimensions of external thread swaged

Art. No. right-handed screw head	Art. No. left-handed screw head	Câble Ø [mm]	Matériau	a	b [mm]	c [mm]	Ø d [mm]
30850-0600-030	30855-0600-030	6,0	1.4404	M10	80	30	10
30850-0600-060	30855-0600-060				110	60	10
30850-0600-080	30855-0600-080				130	80	10
30850-0800-080	30855-0800-080	8,0		M12	157	80	13
30850-0800-120	30855-0800-120				197	120	13
32850-0800 -01	32855-0800-01				175	80	16,1
30850-1000-110	30855- 1000-110	10,0		M16	210	100	18
32850-1000-01	32855-1000-01				205	90	17,9
30850-1200-120	30855-1200-120	12,0		M20	255	120	20
32850-1200 -01	32855-1200-01				235	100	21,4
32850-1400-01	32855-1400-01	14,0		M24	282	12	25
30850-1600-120	30855-1600-120	16,0			283	120	27
32850-1600-01	32855-1600-01				300	120	28,2
32850-1900-01	32855-1900-01	19,0		M30	362	150	34,5
30850-2000-150	30855-2000-150	20,0			341	150	32
32850-2200-01	32855-2200-01	22,0			390	150	40,5
32850-2600-01	32855-2600-01	26,0	M36	420	160	46	

Article group 30850 must only be used in combination with round strand ropes.

Article group 32850 must only be used in combination with spiral ropes.

Rope net constructions Jakob Rope Systems Webnet

External thread swaged

Annex 11

Table 12.1: Net ropes, threading ropes, boundary ropes

Rope type	Rope construction	Rope Ø [mm]	Individual rope material	Rope tensile strength [N/mm ²]	
Net ropes, Threading ropes	Round strand rope with steel insert 6x7+wire strand rope (WSC)	1,5	1.4401	≥ 1570	
		2,0			
		2,5			
	Round strand rope with steel insert 6x19+wire strand rope (WSC)	3,0			
		4,0			
		5,0			
Threading rope	Round strand rope with steel insert 6x19+wire strand rope (WSC)	6,0			
Boundary rope	Round strand rope with steel insert 6x7+wire strand rope (WSC)	6,0			
		8,0			
		8,0			
	Round strand rope with steel insert 6x19+wire strand rope (WSC)	10,0			
		12,0			
		16,0			
		20,0			
		20,0			
	Spiral rope 1x19 (Ø 26 1x37)	8,0			
		10,0			
		12,0			
		14,0			
		16,0			
		19,0			
		22,0			
26,0					

Rope net constructions Jakob Rope Systems Webnet

Ropes (threading ropes, net ropes), boundary ropes

Annex 12

Table 13.1: Systems permitted for use as vertical fall protection:

Nominal diameter net rope [mm] / sleeve	Mesh width area [mm]	Boundary connection / Geometry	Minimum field dimensions [m] x [m]
1,5 / Micro	25 to 120	Boundary rope Ø 6 mm 6x7+WC to Ø 26 mm 1x37 Frames RR 26,9 x 2 à RR 50 x 5 Frames RR 17,2 x 1,6*	1,0 x 0,8
	25 to 100	Inviss* QHP 20 x 1,5 à QHP 40 X 3	
2,0 / Inox	40 to 120	Boundary rope Ø 6 mm 6x7+WC to Ø 26 mm 1x37 Frames RR 26,9 x 2 à RR 50 x 5 Frames RR 17,2 x 1,6*	
	40 to 100	Inviss* QHP 20 x 1,5 à QHP 40 x 3	
3,0 / Inox	40 to 120	Boundary rope Ø 6 mm 6x7+WC to Ø 26 mm 1x37 Frames RR 26,9 x 2 bis RR 50 x 5	
1,5 / sleeveless	30 to 120	Boundary rope Ø 6 mm 6x7+WC to Ø 26 mm 1x37	
	30 to 100	Frames RR 17,2 x 1,6* Inviss* QHP 20 x 1,5	
2,0 / sleeveless	40 to 120	Boundary rope Ø 6 mm 6x7+WC to Ø 26 mm 1x37 Frames RR 26,9 x 2 à RR 50 x 5 Inviss* QHP 20 x 1,5 à QHP 40 x 3 RR 17,2 x 1,6*	
3,0 / sleeveless	40 to 120	Boundary rope Ø 6 mm 6x7+WC to Ø 26 mm 1x37 Frames RR 26,9 x 2 à RR 50 x 5	
4,0 / sleeveless	40 to 120	Boundary rope Ø 8 mm 6x7+WC to Ø 26 mm 1x37 Frames RR 26,9 x 2 à RR 50 x 5	
5,0 sleeveless	100 to 120	Boundary rope Ø 10 mm 6x19+WC to Ø 26 mm 1x37 Frames RR 26,9 x 2 à RR 50 x 5	

* Boundary connections with Inviss-profiles and RR 17.2 must only be used as infill panels for railings.

RR: round tubing

QHP: Square hollow sections

Rope net constructions Jakob Rope Systems Webnet

Systems permitted for use as horizontal fall protection

Annex 13

Table 14.1: Systems permitted for use as horizontal fall protection:

Nominal diameter net rope [mm] / sleeve	Mesh width area [mm]	Boundary connection / Geometry	Minimum field dimensions [m] x [m]
2,0 / Inox	25 to 60	Boundary rope Ø 6 mm 6x7+WC to Ø 26 mm 1x37	1,0 x 1,0
	25 to 80	Frames RR 26,9 x 2 à RR 50 x 5	
3,0 / Inox	40 to 120	Boundary rope Ø,6 mm 6x7+WC to Ø 26 mm 1x37 Frames RR 26,9 x 2 à RR 50 x 5	
2,0 / sleeveless	40 to 50	Frames RR 26,9 x 2 à RR 50 x 5	
3,0 / sleeveless	40 to 100	Boundary rope Ø 8 mm 6x7+WC to Ø 26 mm 1x37 Frames RR 26,9 x 2 à RR 50 x 5	

RR: round tubing

With identical boundary connections, larger net rope diameters up to max. 5 mm and/or smaller mesh widths may also be used.

With systems used to provide horizontal fall protection, a net orientation parallel to the longest side is obligatory.

Alternatively, tubular sections with a bending stiffness between the stated min. and max. values may be used.

Boundary structures must be supported/stabilized at least every 2.5 m.

Rope net constructions Jakob Rope Systems Webnet

Systems permitted for use as horizontal fall protection

Annex 14